

WPV 150

Wide-span coupler, height=150 mm

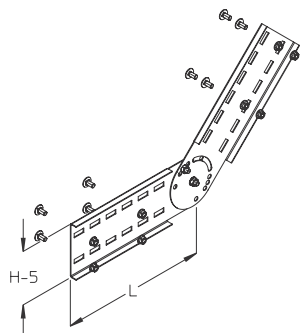

All other angles up to 90° maximum are to be set above the elongated holes I.

This article is available made in material No. 1.4571/1.4404 (V4A) stainless steel finish.

Continuously hot galvanized (Sendzimir process) (DIN EN 10346)

Product	H	L	G
WPV 150S	150 mm	377 mm	2,43 kg

Incl.:			
8x KLS 10X20 2x SES 10X20 2x SEM 10 1x FS 10		Fixing set Hexagon head bolt, DIN 933 Hexagon-nut, DIN 934 Serrated lock washer	

Hot-dip galvanized, according to BS 729 (DIN EN ISO 1461)

Product	H	L	G
WPV 150F	150 mm	377 mm	2,60 kg

Incl.:			
8x KLS 10X20F 2x SES 10X20F 2x SEM 10F 1x FS 10E		Fixing set Hexagon head bolt, DIN 933 Hexagon-nut, DIN 934 Serrated lock washer	

Stainless steel, according to ASTM 304 / BS 304 S 3

Product	H	L	G
WPV 150E	150 mm	377 mm	2,43 kg

Incl.:			
8x KLS 10X20E 2x SES 10X20E 2x SEM 10E 1x FS 10E		Fixing set Hexagon head bolt, DIN 933 Hexagon-nut, DIN 934 Serrated lock washer	



H : Height
L : Length
G : Weight

DETAILS / APPLICATIONS

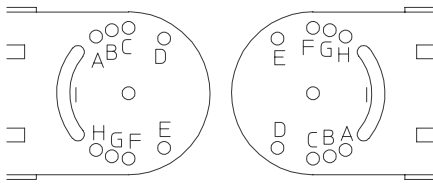

- 15° C + G
- 18° E + B
- 30° A + F
- 45° B + H
- 60° A + H

